

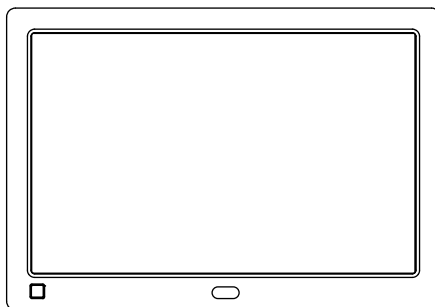

Wi-Fi Digital Photo Frame

USER MANUAL

Model: X10



Congratulations on purchasing your new Wi-Fi Digital Photo Frame. With this Digital Photo Frame, you can easily and quickly receive photos directly from your android/iOS smartphones and iPad through the included (downloadable) App or Web Portal. You can also view photos directly from an external memory card or USB Flash Drive. The Digital Photo Frame is compatible with the following external memory devices: Secure Digital (SD) card, Secure Digital High Capacity (SDHC), Multi Media Card (MMC) and USB Flash Drives.

Contents

CONTACT US.....	2
WHAT'S IN THE BOX.....	3
GET TO KNOW YOUR DIGITAL PICTURE FRAME.....	4
PRODUCT FEATURES.....	4
PRODUCT SPECS.....	4
SYSTEM REQUIREMENTS.....	5
FRONT AND BACK SIDE OF FRAME.....	5
REMOTE CONTROL.....	7
IMPORTANT SAFETY PRECAUTIONS.....	8
SAFETY INSTRUCTIONS.....	8
CARE AND MAINTENANCE.....	9
SETUP AND CONNECTION.....	9
SEND AND VIEW PHOTOS/VIDEOS FROM LOVCUBE APP.....	18
LOVCUBE APP INSTRUCTIONS.....	22
WEB PORTAL.....	31
INSTRUCTIONS OF THE WIFI FRAME.....	32
CONNECTING WITH A USB DRIVE OR SD CARD.....	35
FULL ONE YEAR MANUFACTURER'S WARRANTY	36
OBTAINING WARRANTY SERVICE.....	36

CONTACT US

In case you face any issues with the product you have received, please contact our support team. We will respond to your queries within 24 hours.

Support Team Email: support@lovcube.com

You can also submit your questions/feedbacks through the Lovcube App.

- 1) Go to your account by selecting “Me”.
- 2) Click on “Feedback questions”.

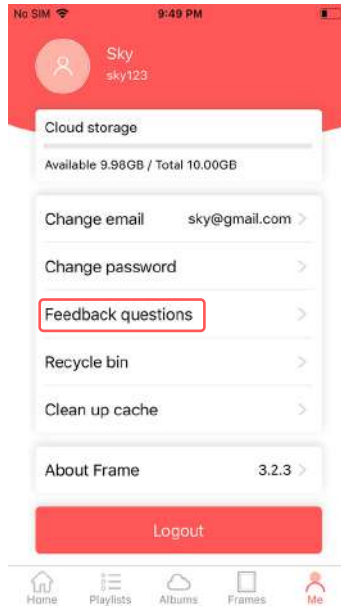

WHAT'S IN THE BOX

Please check the accessories as soon as you receive the frame to make sure you have all of them.

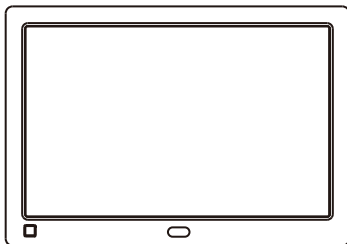

LOVCUBE Digital Picture Frame *1 pcs

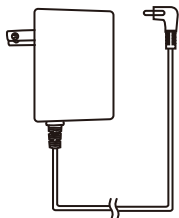

Power Adaptor * 1pcs

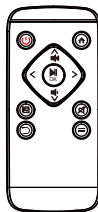

Remote Control * 1pcs

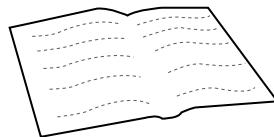

User Manual * 1pcs

GET TO KNOW YOUR DIGITAL PICTURE FRAME

1 PRODUCT FEATURES

- 1280 x 800 high resolution IPS screen for better visual effect of photos
- Free 10GB cloud storage for storing your favorite photos
- Wi-Fi enabled internet photo frame with Lovcube App or Web Portal
- Wi-Fi connected frame allows you to send photos/videos from Android/iOS smart phones and iPad to the frame
- Pair multiple phones/devices (Android/iOS) to one frame or one phone/device to multiple frames
- Personalized playlist group your treasured photos and enable sharing to be easy
- Customizable slideshow transition effects
- Programmable sleep timer turns display on/off automatically
- Motion sensor available; the frame turns on when someone is near the picture frame and turns off when no one is around
- View photos, musics, videos from your USB drive or SD card.

2 PRODUCT SPECS

- Wi-Fi: WLAN built-in Wi-Fi module; supports IEEE 802.11 b/g/n
- File format: supports JPG, BMP, PNG pictures files; supports MP4 video files with resolution of 1920x1080; supports MP3, WMA audio files
- I/O interface: USB 2.0 port*1, SD/MMC port*1, 3.5mm earphone jack*1
- Power: adaptor input (100-240V, 50/60Hz), adaptor output (DC output, 5V/1.5A)
- Screen: Non-touch screen with high-resolution 1280x800, Aspect Ratio 16:10
- Storage: 10GB cloud storage
- Supported external memory devices: SD, SDHC, MMC, and USB flash drive, Maximum support 64GB, not included in the standard package
- Operating temp: 0°C to 40°C, storage temp: -10°C to 60°C
- Operating humidity: 10-90% (non-condensing)

3 SYSTEM REQUIREMENTS

- Wi-Fi router with a 2.4GHz internet connection
- Android mobile device with OS 6.0 or higher, or Apple mobile device with iOS 10.0 or higher

NOTE: These products are *NOT* compatible with Linux or Windows phones

4 FRONT AND BACK SIDE OF FRAME

Front of Frame

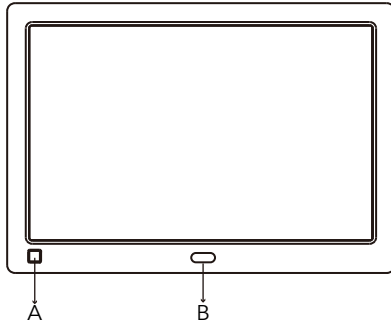

Back of Frame

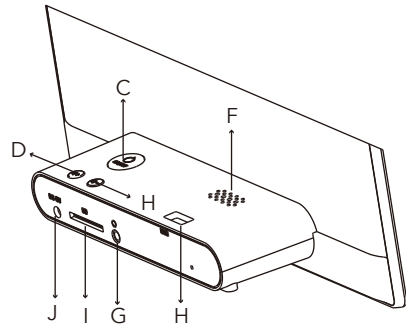

A: Motion Sensor

Senses movement and turns the Digital Frame on and off.

B: Infra-red Sensor

Receives signals from the remote control.

C: Power Button

Turns the Digital Frame on or puts it into standby.

D: Volume Up

Volume up when playing videos, musics.

E: Volume Down

Volume down when playing videos, musics.

F: Loudspeakers

Built-in loudspeakers for musics and videos.

G: Headphone/Speaker Port

Connect your headphones or speakers.

H: USB Port

Insert a USB drive to view photos, musics and videos.

I: SD/MMC Card Slot

Connect and view photos, musics and videos from the memory card.

J: Power Adaptor DC-IN (5V)

Plug in power adaptor for power.



1. Blocking the infrared or motion sensor will cause those functions to fail.
2. The USB port designed only for reading USB drives, neither for charging or other use.

5 REMOTE CONTROL

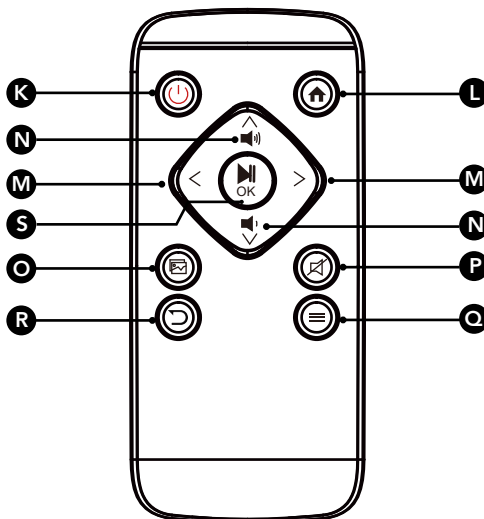

K:  ON/OFF Button - Turns the frame on or puts it into standby

L:  Home - Go back to home menu

M:  Move cursor left/right

N:  Move cursor up/down. Up/Down volume when playing videos, musics

O:  Slideshow -Starts slideshow

P:  Mute

Q:  Sub-menu - Enter sub-menu

R:  Back - Return to the previous menu

S:  Play - Select/Play/Pause



1.Push catch toward slot.

2.With the catch pushed, pull the battery compartment at the same time.

3.Use the Lithium cell, CR-2025 type.

4.Remove battery stopper for first time use. Maximum working distance is six meters.

6 IMPORTANT SAFETY PRECAUTIONS

- High voltage product. Please do not open the casing of the digital photo frame. Servicing of the frame should be done by qualified personnel only.
- To reduce the risk of fire or electric shock, do not expose this product to rain or moisture.
- To avoid permanent loss of data, do not insert or remove memory cards or USB devices when the frame is powered on.

7 SAFETY INSTRUCTIONS

- Do not expose the product to liquids or objects filled with liquids, such as vases. Use in a dry location only.
- Keep product away from open flames, such as candles.
- Keep the digital photo frame clean and never store it near a heat source or in dirty, humid, or wet places. Keep it out of direct sunlight.
- Do not drop the product. It may result in damage to the product and loss of data.
- Do not attempt to repair or disassemble the unit by yourself. Only qualified service personnel should perform repairs.
- The digital photo frame is for indoor use only.
- Use only the DC 5V/1.5A power adaptor supplied with this product. Do not unplug the adaptor while viewing the pictures.
- Do not block the ventilation holes on the back of the digital photo frame.
- Children should be supervised to ensure safety.
- To prevent overheating and damage to the screen, unplug the product when you do not intend to use it for a long period of time.
- Please insert the plug into the DC IN jack on the unit completely before connecting the AC adaptor to an electrical outlet.
- This product can only display files with compatible formats.
- Do not use the product in extreme temperatures over 105° F (40° C).
- Do not allow metallic objects to touch the DC plug when the player is on.

8 CARE AND MAINTENANCE

- Always turn off the unit and remove the power adaptor from the electrical outlet before cleaning the unit.
- Use a soft dry cloth to clean this product.
- Never spray or pour liquids directly onto the screen or casing.
- Do not use abrasive materials or chemical cleaners such as alcohol, benzene, etc. Do not allow any water or other liquid to enter the device.
- Do not drop the device as the devices cannot withstand shock from falls.
- Do not hit or scratch the screen. Handle it with care. The LCD panel of the photo frame may be damaged due to excessive force or if it comes in contact with sharp objects.

SETUP AND CONNECTION

IMPORTANT: Before you install your Wi-Fi frame

- Peel back and remove plastic screen protector from the LCD panel using the tab in the upper right corner.
- Keep the frame as close to the Wi-Fi router as possible, preferably within 10 feet.
- If you are going to place your frame more than 20 feet from your router or on another floor you may require a Wi-Fi extender.

Connect the frame using the included power adaptor, and the frame will automatically turn on. Follow the below on-screen instructions to set up your frame.

NOTE: *When the frame powers on the LOVCUBE logo be drawn three times will on the screen while the system initializes (around 45 seconds) .*

1 Setup the language and time zone

Please select your preferred language and time zone and click next.

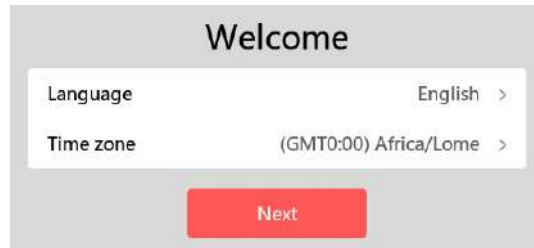

2 Wi-Fi setup

- All the nearby available Wi-Fi networks will be listed on the device.
- Select your Wi-Fi network from the list.



c) Enter the Wi-Fi password by pressing the 4-way direction arrow button of the remote control. It is necessary for you to press "OK" to confirm each letter you enter. And click  for confirmation when you finish inputting all the letters of the password. After Wi-Fi is connected, a tick will appear.



3 Download the Lovcube App on your Android/iOS devices

There are two options for you to download the Lovcube App.



L O V C U B E

Option 1: Scan the related QR code on the frame to download it.

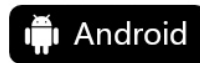

Option 2: Available on the App Store or Google Play for your Android/ iOS smartphones and iPad.

Search "Lovcube" in App Store or Google Play to download it



4 Create an account on Lovcube App

Create an account before the first-time use. It is mandatory to create an account before using the device. Follow the on-screen instructions to create your account.

The image displays three sequential screenshots of the Lovcube app's account creation interface. The first screenshot, titled "Create an account", shows a registration form with fields for "username" (filled with "susan"), "password" (two masked fields), and "captcha" (filled with "mtx2"). A red "Create an account" button is at the bottom, with links for "Service Agreement" and "Privacy Policy" below it. The second screenshot, titled "Complete your information", shows a profile completion form with fields for "Profile" (with a camera icon), "Nickname" (filled with "susan"), "Email" (filled with "susan@gmail.com"), "Get your password back" (a text input field), "Question" (filled with "Where I born?"), and "Answer" (filled with "New York"). A red "Complete" button is at the bottom. The third screenshot shows a "Please pair your frame" screen with a placeholder image of a frame and a red "Pair frame" button, with a "Logout" link below it.

NOTE: Username and captcha are case insensitive. Password is case sensitive. So please note which letters you capitalize.

5 Pair the frame

Click "Pair frame"

a-1) Scan the QR code to pair the frame.

Scan the QR code and follow the on-screen instructions and enter all the required information to pair the frame.

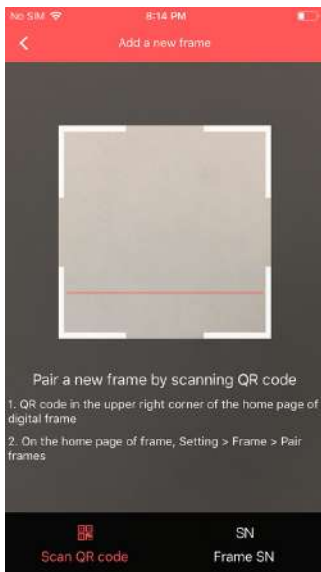

a-2) Input the SN number to pair the frame.

Input the SN number, Click "Sure" on Lovcube App. Then you can see the below window appearing on the home screen of your digital picture frame. Choose "Agree".

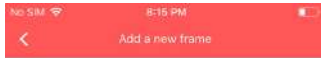

Frame SN 3566 5464 8434 7848

1. SN in the upper right corner of the home page of digital frame
2. On the home page of frame, Setting > Frame > Pair frames > SN

Sure



Scan QR code

SN

Frame SN

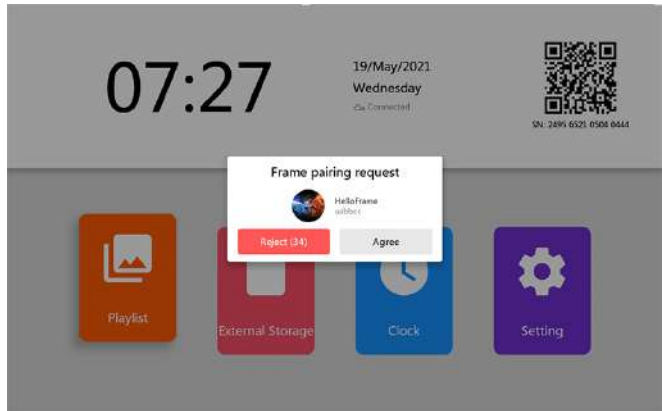

b) Input the frame name and upload the frame cover.

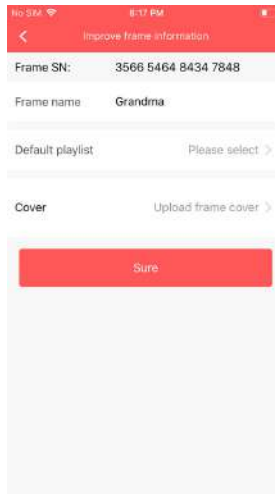

c) Create a default playlist by below steps.

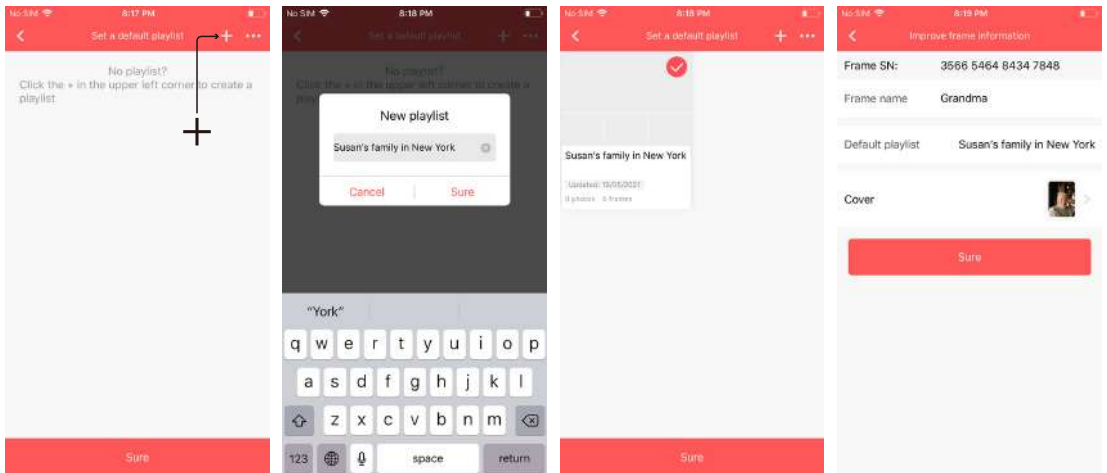

d) Click "Sure" to proceed and the frame is paired successfully when you see the below window screen.

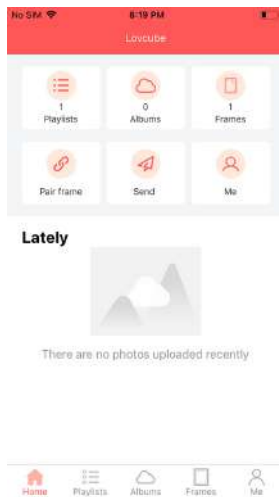

Important Notice 1: The SN number of the device shown on below two different windows for your easy use. They are same SN number and both workable

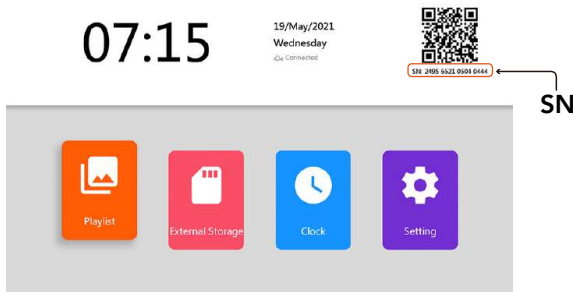
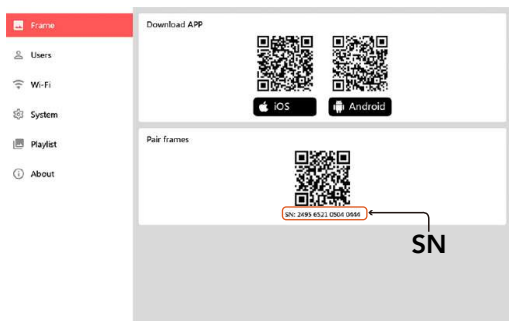

Important Notice 2: For first-time use, it is necessary for you to create at least one default playlist for your personal use. This default playlist is added to the paired frame automatically. All the photos/videos you send will be saved in this playlist as default. Of course, You can change the default playlist if you have one more playlist.

SEND AND VIEW PHOTOS/VIDEOS FROM LOVCUBE APP

There are three options for the user to send photos/videos to the paired Wi-Fi digital picture frame to play.

1 Send photos/videos to the Wi-Fi photo frame by "Send"

Once Setup is complete you will be able to send photos/videos from your mobile devices to the frame. The following flowchart shows the detailed steps to send photos.

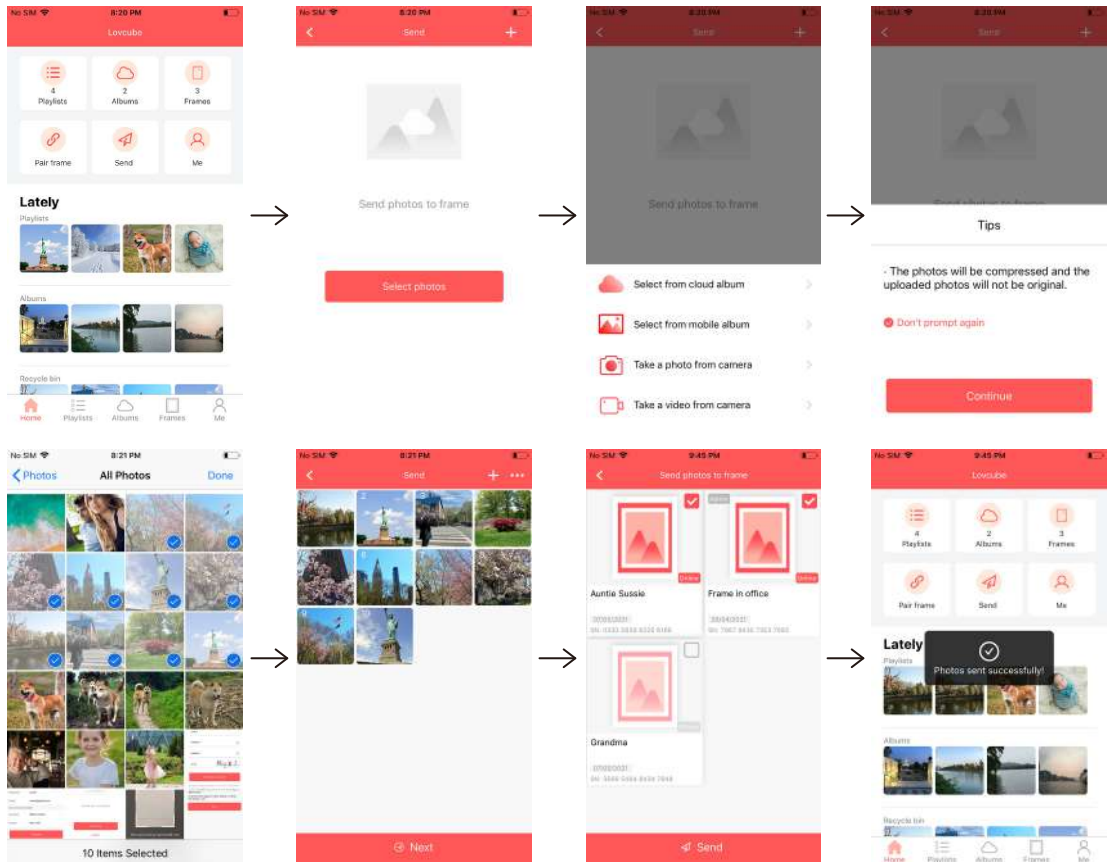

NOTE: We strongly recommend that you only play in those “Online” frames. Those “Offline” frames will not receive the photos/videos you send.

2 Send photos/videos to the Wi-Fi photo frame using “playlist” on Lovcube App

a) The red triangle quick share button is available on the playlist section. We call this triangle button as “Play Button”. You can click it to share the full photos/videos from the selected playlist to all paired frames.

NOTE: The Digital Photo Frame will display all the photos/videos added under the playlist. There are no options to display only some from the playlist.

Please make sure that the playlists are added to the correct Digital Photo Frame in case you have multiple frames.

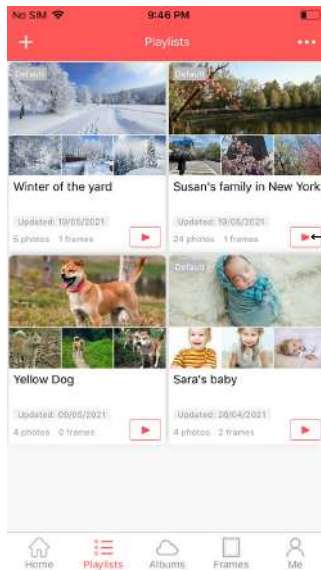

Play Button

b) You can also click a playlist icon to enter the editing interface. Then click "Frames", you will see all frames paired with this playlist. Choose one frame and click "Play Button", so you will play this playlist in selected frame only.

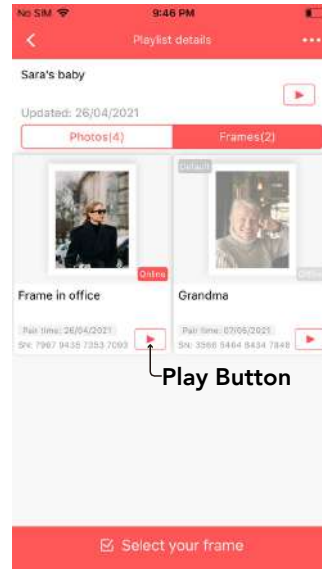
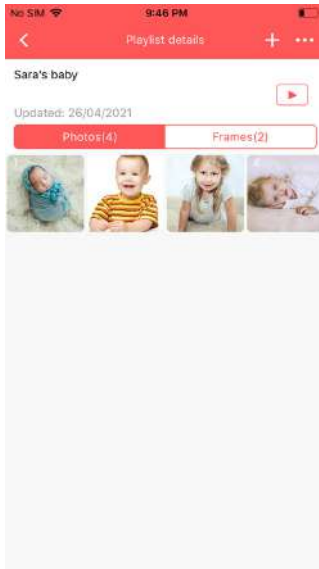

3 Send photos/videos to the Wi-Fi Photo Frame using “Frames” on Lovcube App

Under the “Frames” menu, all the playlists will be listed here if they are added to the frame in advance. You can also share the full photos/videos easily by click the red triangle “Play Button”.

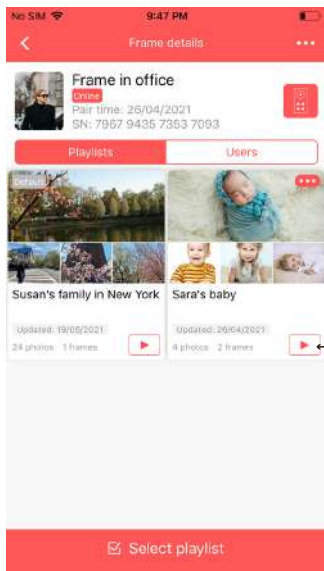

Play Button

LOVCUBE APP INSTRUCTIONS

1 Home screen of Lovcube App

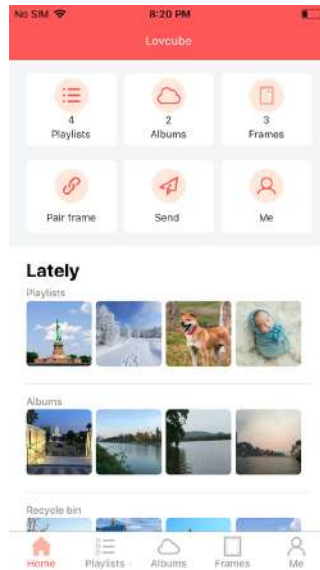

Home

Home screen includes the icons of the Playlists, Albums, Frames, Pair frame, Send and Me. It will jump to the related page for your further action when you choose it.

Playlists

A playlist is simply a collection of photos and videos you upload. You can create different playlists to manage your photos and videos, which makes you to find the intended photos or videos easily from the millions of photos and videos. With the playlist, you can

a) Share your photos/videos quickly by the quick "Play Button".

b) Sort your playlists by pressing  at the right corner of the screen to make sure you can find the photos/videos easily.

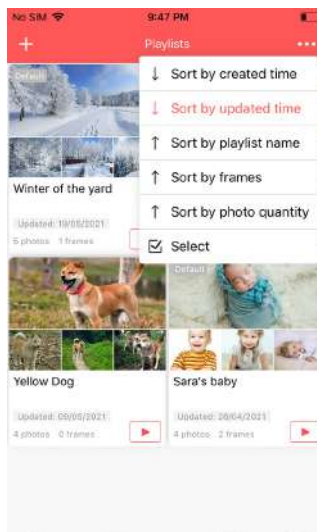
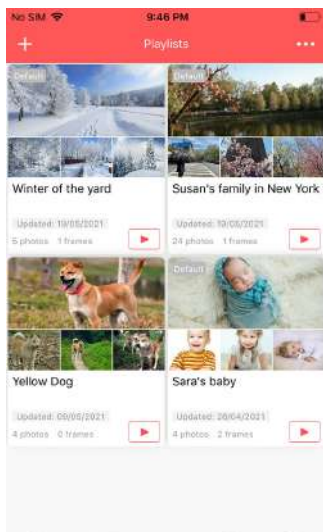

Albums

All the Albums you created will be shown here. You can upload photos/videos to the Albums by Lovcube App or Web Portal. All the photos/videos of the album are saved in the Lovcube cloud server. We provide free 10GB cloud storage for you.

When you log in your account in Web Portal, you can download all photos and videos from your Albums.

NOTE: We strongly recommend that you back up your photos/videos in computer or other storage devices.

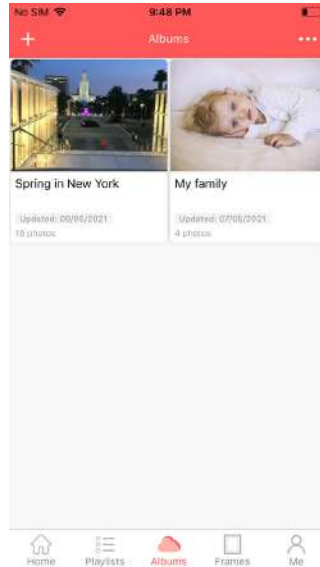

Frames

You can manage your paired frames here.

a) Show all the frames that Lovcube App paired. And you can see the online/offline status of the frames.

b) Under each frame, all the playlists are shown and you can share them easily by click the red triangle “Play Button”.

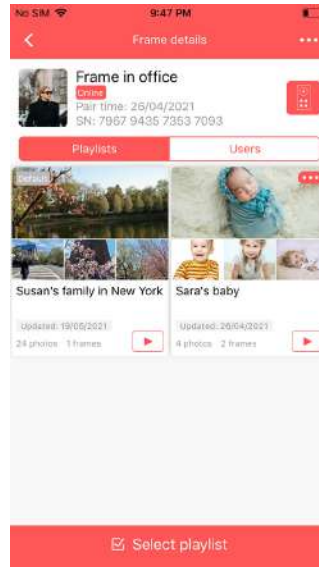
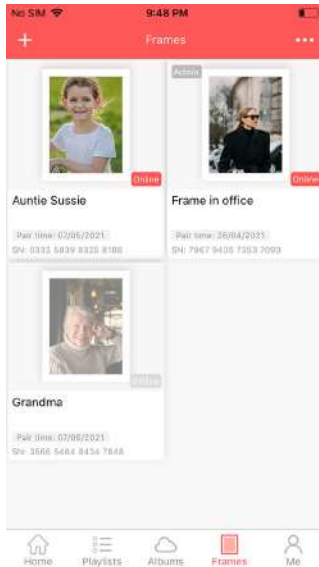

c) If you are set as an administrator of a frame, you can also have below rights,

- 1) You can see all users paired with a frame. In the meanwhile, you can set or cancel a user as an administrator.
- 2) You can control the frame by using below online remote control.

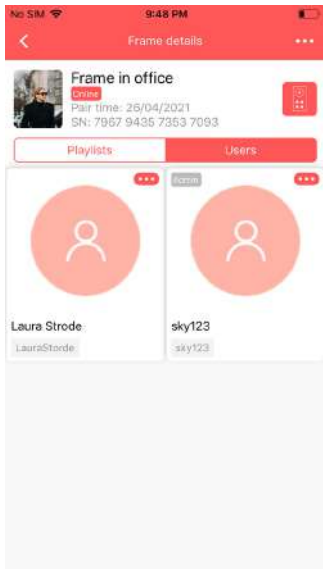

Me

Show some information about your paired frame.

Cloud storage - The maximum memory capacitive is 10GB. All the photos/videos under Playlists or Albums are saved here. It shows the memory size for used and unused.

Change mail - Change your registered email address.

Change password - Change your password if needed.

Feedback questions - It is a window for the user to connect to our customer service team. All the messages will be responded within 24 hours.

Recycle bin - All the deleted photos/videos are saved here temporarily.

Clean up cache - Clean up useless cache files. Cleaning up does not affect normal use.

About Frame - Show "Service Agreement" and "Privacy Policy" of the frame.

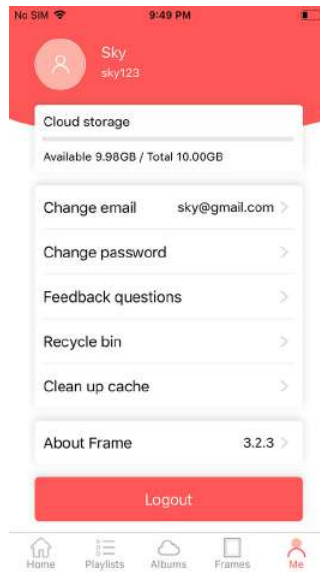

2 Important operations for Lovcube App

a) Create a new playlist

Under "Playlists" menu of the Lovcube App, except for the default playlist you created when registered, it is allowed to create a multi-playlist for easy use. Steps as below.

Create a new
playlist

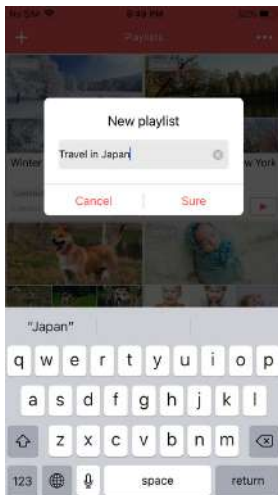
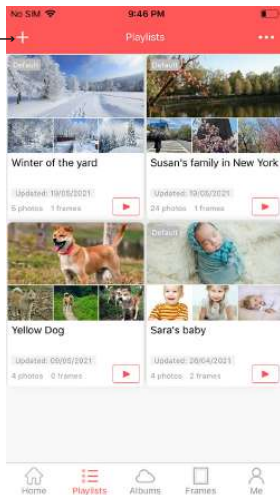

b) Add playlist to your paired frame

Under “Frames” menu of the Lovcube App, it can show all the playlists that added to the frame only. Below are the steps to add new playlists to the frame.

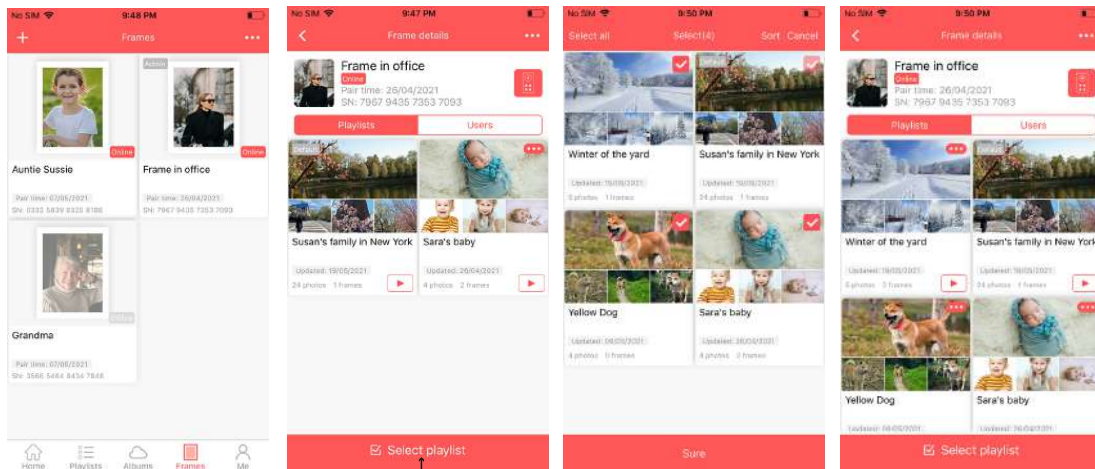

Select playlist

c) Change default playlist or remove playlist

Besides the playlist you created when registered as the default playlist, you can change it when you have more than one playlist under “Frames” menu of the Lovcube App. Below are the steps.

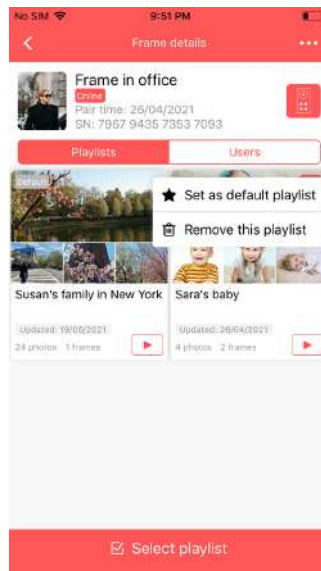
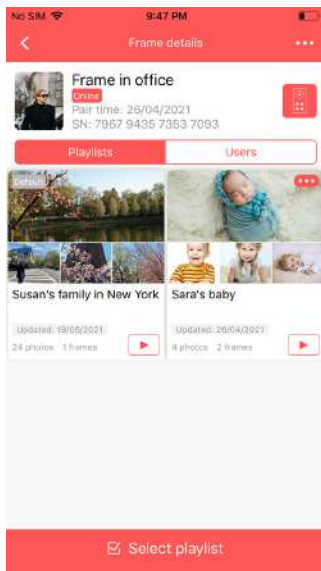
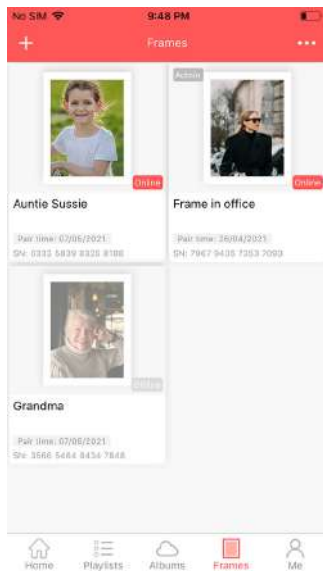

d) Find password back

Forgot your password? Follow the on-screen instructions, you can find it back.

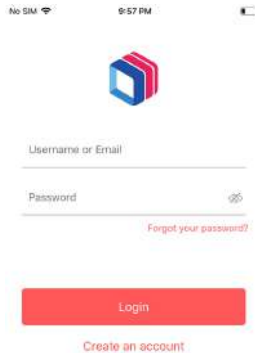

The screenshot shows the Lovcube app's login interface. At the top, the status bar displays 'No SIM', signal strength, '9:57 PM', and battery level. The Lovcube logo is centered. Below it are two input fields: 'Username or Email' and 'Password'. A red link labeled 'Forgot your password?' is positioned below the password field. At the bottom, there is a red 'Login' button and a red link for 'Create an account'.

WEB PORTAL

Besides the Lovcube App, you can also visit www.lovcube.com to upload your photos and videos to the Lovcube cloud and manage your playlists, albums, frames. The login name and password of the Lovcube App can be used in common with www.lovcube.com.

You can download all photos and videos from your Albums here.

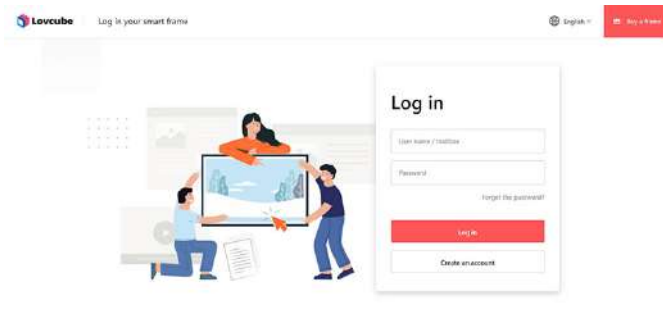

The screenshot shows the Lovcube web portal's login page. The header includes the Lovcube logo, the tagline 'Log in your smart frame', a language selector set to 'English', and a 'Buy a frame' button. The main content area features an illustration of three people interacting with a large screen displaying a landscape photo. To the right, a 'Log in' form is overlaid, containing fields for 'User name / mobile' and 'Password', a 'Forgot the password?' link, a red 'Log in' button, and a 'Create an account' link.

INSTRUCTIONS OF THE WIFI FRAME

Home screen of Digital Photo Frame

07:15

19/May/2021
Wednesday
Connected



SN: 2495 6521 0504 0444

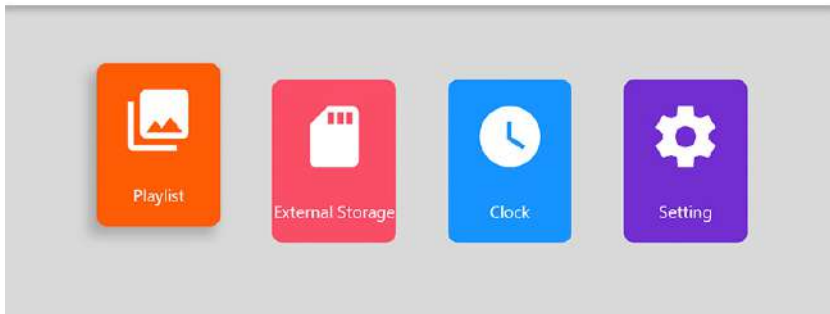

The frame will show the time and date on the top. There's also symbol showing the connecting status between the frame and Lovcube cloud server. When it shows "connecting...", it indicates connecting is on process; when it shows "connected", it indicates connecting is fulfilled.

NOTE: When you set up the frame for the first time, you need connect to Wi-Fi to regulate the time. Each time when you power on the frame after you cut off the power, you need ensure Wi-Fi is successfully connected so that the time can be regulated.

Playlists: Show all the playlists that added to the frame from Lovcube App. The playlists under the frame menu of the Lovcube App are sync to the playlists of Wi-Fi Frame automatically.

External Storage: The Digital Photo Frame supports an external SD/MMC Card or USB drive, Maximum 64GB. You can view photos, musics, videos from your USB drive or SD card.

Clock: Display a clock.

Setting: Navigate the setting menu using the 4-way navigation pad on the remote control.

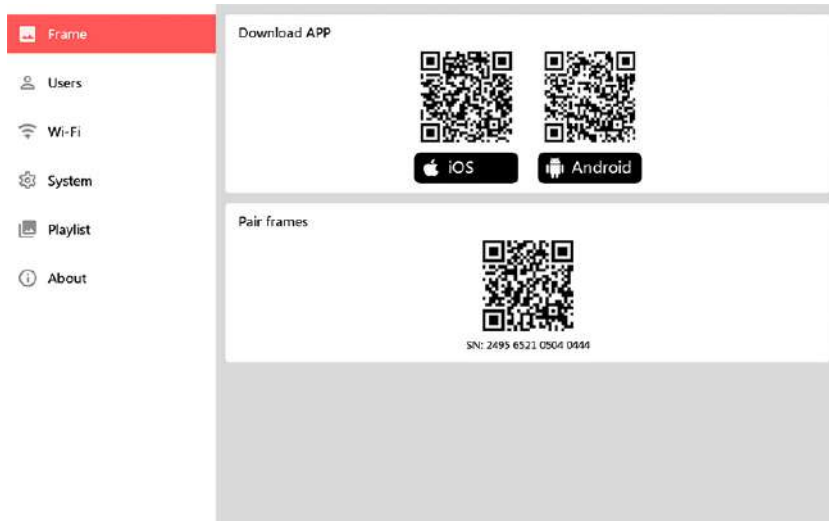

Item	Content for setting	Functions
Frame	Show APP Download QR Code	Download App
	Show SN number of the frame	Pair frames
Users	All the paired APP users are listed here, you can set up admin here	Set or cancel Admin
	Delete App user	Delete user of App
Wi-Fi	Wi-Fi Setup	Connect to Wi-Fi
System	Language	Set your language
	Time Zone	Set your time zone
	Brightness	Adjust the brightness
	Volume	Adjust the volume
	Sleep schedule	Set sleep mode start & end time
	Motion sensor	Set sleep time of motion sensor
	Auto slideshow	Set waiting time of auto slideshow if not any operation
	12-Hour time	Set 12-Hour time or 24-Hour time
Playlist	Transition type	Set transition effect of slideshow
	Transition time	Set transition time of slideshow
	Show caption	Set whether or not to display the captions that your friends have sent with the photo
	Show clock	Set whether or not to show clock and date when slideshow
	Show playlist owner's profile	Set whether or not to show the sender of playlist
	Show serial number	Set whether or not to show the sequence no of photo or video

Playlist	Auto play all playlists	Set whether or not to play all playlists
	Random play	Set whether or not to play in random turn
About	Model name	Show the model No of frame
	Frame serial number	Show SN of frame
	Display resolution	Show resolution of frame
	MAC address	Show MAC address of frame
	Check for update	Update the OS of frame
	Restore to factory settings	Restore to factory setting

View photos on the Wi-Fi Digital Photo Frame

Once the frame receives the photos which you send by "Send", you will see a notification on the display that new photos are received. Then the new photos will be played on the inserted position at the beginning of the slide show and be displayed in sequence.

Once the frame receives the photos which you send by "Playlists". You will see a notification on the display that the new playlist is received. All the photos/videos under the playlist will be played one by one.

Navigate the Digital Photo Frame using the 4-way navigation pad on the remote control.

CONNECTING WITH A USB DRIVE OR SD CARD

To view photos from USB drive/SD card, insert it into the related port on the back side of the frame. Then choose the "External Storage" icon of the home menu by remote control, and press "OK" for confirmation. The Digital Frame will start to play the photos/videos included in the SD/MMC card or USB Drive

NOTE: SD/MMC card and USB storage support 64GB maximum.

Do not force the memory card into the slot. If you are not able to insert the memory card easily, you may have inserted it incorrectly; turn the card over and try again.

Do not remove a memory card immediately after inserting it or when the frame is processing files. Wait until the screen is stable.

FULL ONE YEAR MANUFACTURER'S WARRANTY

LOVCUBE warrants the product hardware components against defects in materials and workmanship when used in accordance with the company's documentation for a period of one (1) YEAR after the date of original purchase from the company. If a hardware defective arises and a valid claim is received within the Warranty Period, at its option and to the extent permitted by law, Company will either (1) repair the hardware defect at no charge, using new or refurbished replacement parts, (2) exchange the product with a new or manufactured from new or serviceable used parts and is at least functionally equivalent to the original product or (3) refund the purchase price of the product.

We only cover warranty for purchase made within the USA, Canada, UK.

OBTAINING WARRANTY SERVICE

Please access and review the online help resources referred to in the documentation accompanying this hardware product before requesting warranty service. If the product is still not functioning properly after making use of these resources, please contact our representatives at support@lovcube.com. No replacements will be sent out by the manufacturer until the returned item is received.

