

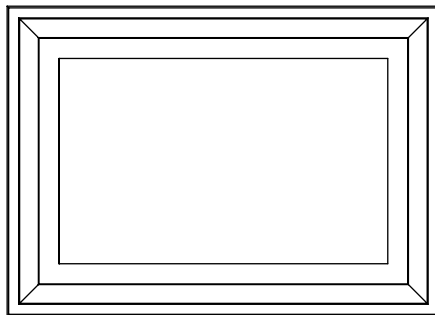

Wi-Fi Digital Photo Frame

USER MANUAL

Model: F20W



Contents

CONTACT US.....	2
WHAT'S IN THE BOX.....	3
GET TO KNOW YOUR DIGITAL PICTURE FRAME.....	4
PRODUCT FEATURES.....	4
PRODUCT SPECS.....	4
SYSTEM REQUIREMENTS.....	5
FRONT AND BACK SIDE OF FRAME.....	5
WALL MOUNT YOUR FRAME.....	6
IMPORTANT SAFETY PRECAUTIONS.....	7
SAFETY INSTRUCTIONS.....	7
CARE AND MAINTENANCE.....	8
GET YOUR FRAME READY.....	9
GETTING STARTED.....	10
FRAMEO QUICK SETUP.....	11
START USING FRAMEO.....	11
NAVIGATING YOUR FRAMEO.....	12
SETTINGS.....	15
PRIVACY.....	21
SUPPORT.....	21
FULL ONE YEAR MANUFACTURER'S WARRANTY.....	22
OBTAINING WARRANTY SERVICE.....	22

CONTACT US

In case you face any issues with the product you have received, please contact our support team by:

support@lovcube.com

We will offer prompt and authoritative reply within 24 hours and try our best to solve your problem ASAP! More Safe Guarantee with LOVCUBE! If you are not satisfied with our product, please tell us about your thought. That would be much appreciated.

WHAT'S IN THE BOX

Please check the accessories as soon as you receive the frame to make sure you have all of them.

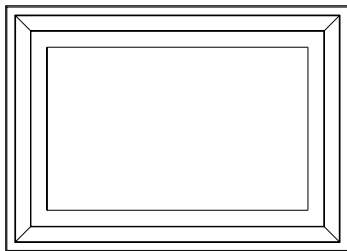

LOVCUBE Digital Picture Frame *1 pcs

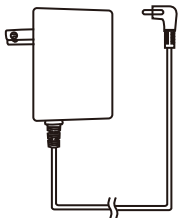

Power Adaptor * 1pcs

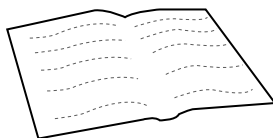

User Manual * 1pcs

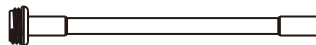

Kickstand * 1pcs

GET TO KNOW YOUR DIGITAL PICTURE FRAME

1 PRODUCT FEATURES

- 1280 x 800 high resolution IPS touchscreen
- Decorative frame
- Wi-Fi enabled internet photo frame with free Frameo App
- Wi-Fi connected frame allows you to send photos/videos from Android/iOS smart phones and iPad*
- Pair multiple phones/devices (Android/iOS) to one frame or one phone/device to multiple frames
- Photos can be stored on frame(16GB of internal memory*)
- Easily backup all your photos and contacts on a SD card
- Import photos from your computer or camera to your frame via SD card or USB drive
- Customizable slideshow transition effects
- Programmable sleep timer turns display on/off automatically

**1 This photo frame only supports 15 seconds MP4 videos.*

**2 The photo frame has 16GB built-in storage, however the operating system will take up some storage space.
The total usable storage space for photos and videos is about 12GB.*

2 PRODUCT SPECS

- Wi-Fi: WLAN built-in Wi-Fi module; supports IEEE 802.11 b/g/n
- File format: supports JPG, BMP, PNG pictures files
- I/O interface: USB 2.0 port*1, SD/SDHC port*1, 3.5mm earphone jack*1
- Power: adaptor input (100-240V, 50/60Hz), adaptor output (DC output, 5V/2A)
- Screen: touch screen with high-resolution 1280x800, Aspect Ratio 16:10
- Storage: 16GB of internal memory
- Operating temp: 0°C to 40°C, storage temp: -10°C to 60°C
- Operating humidity: 10-90% (non-condensing)

3 SYSTEM REQUIREMENTS

- Wi-Fi router with a 2.4GHz internet connection
- Android mobile device with OS 6.0 or higher, or Apple mobile device with iOS 10.0 or higher

NOTE: These products are NOT compatible with Linux or Windows phones

4 FRONT AND BACK SIDE OF FRAME

Front of Frame

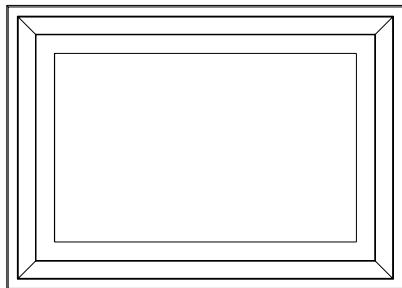

Back of Frame

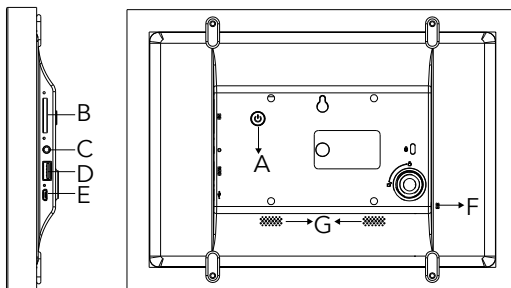

A: Power Button

Turns the Digital Frame on or puts it into standby. Long press around three seconds for turning on/off, short press for standby.

B: SD/SDHC Card Slot

Import photos to the digital photo frame from a SD card(max 32GB).

C: Headphone/Speaker Port

Connect your headphones or speakers.

D: USB Port

Import photos to the digital photo frame from a USB drive(max 32GB).

E: Micro USB Port

For after sale service only.

F: Power Adaptor DC-IN (5V)

Plug in power adaptor for power.

G: Loudspeakers

Built-in loudspeakers for videos.

5 WALL MOUNT YOUR FRAME

You have two ways to mount your frame on the wall.

- 1) Drill a screw on the wall, leave a 10mm gap between the wall and the head of screw. Mount the frame onto the screw by wall mount hole and slide down to lock into place.
- 2) Prepare a VESA mount bracket*. Lock the VESA mount bracket into the VESA holes on the back side of the frame. Then you can hang the frame on the wall.

*It is not included in our merchandise.

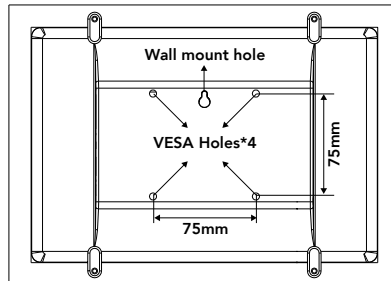

6 IMPORTANT SAFETY PRECAUTIONS

- High voltage product. Please do not open the casing of the digital photo frame. Servicing of the frame should be done by qualified personnel only.
- To reduce the risk of fire or electric shock, do not expose this product to rain or moisture.
- To avoid permanent loss of data, do not insert or remove memory cards or USB devices when the frame is powered on.

7 SAFETY INSTRUCTIONS

- Do not expose the product to liquids or objects filled with liquids, such as vases. Use in a dry location only.
- Keep product away from open flames, such as candles.
- Keep the digital photo frame clean and never store it near a heat source or in dirty, humid, or wet places. Keep it out of direct sunlight.
- Do not drop the product. It may result in damage to the product and loss of data.
- Do not attempt to repair or disassemble the unit by yourself. Only qualified service personnel should perform repairs.
- The digital photo frame is for indoor use only.
- Use only the DC 5V/1.5A power adaptor supplied with this product. Do not unplug the adaptor while viewing the pictures.
- Do not block the ventilation holes on the back of the digital photo frame.
- Children should be supervised to ensure safety.
- To prevent overheating and damage to the screen, unplug the product when you do not intend to use it for a long period of time.
- Please insert the plug into the DC IN jack on the unit completely before connecting the AC adaptor to an electrical outlet.
- This product can only display files with compatible formats.
- Do not use the product in extreme temperatures over 105° F (40° C).
- Do not allow metallic objects to touch the DC plug when the player is on.

8 CARE AND MAINTENANCE

- Always turn off the unit and remove the power adaptor from the electrical outlet before cleaning the unit.
- Use a soft dry cloth to clean this product.
- Never spray or pour liquids directly onto the screen or casing.
- Do not use abrasive materials or chemical cleaners such as alcohol, benzene, etc. Do not allow any water or other liquid to enter the device.
- Do not drop the device as the devices cannot withstand shock from falls.
- Do not hit or scratch the screen. Handle it with care. The LCD panel of the photo frame may be damaged due to excessive force or if it comes in contact with sharp objects.

GET YOUR FRAME READY

- 1 Place your frame on a flat surface, face down and attach the screw-in kickstand.

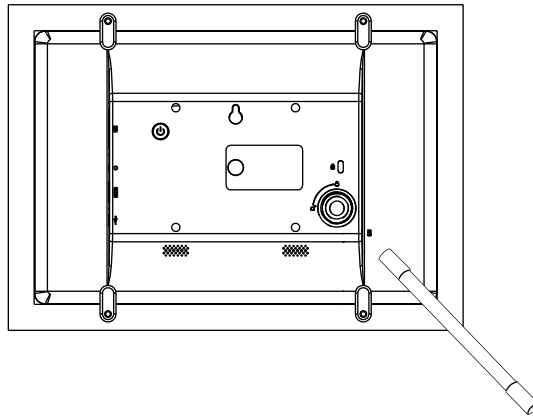

2 Bend the kickstand to stand and to support the frame, position the frame in either portrait or landscape orientation. Don't worry: the kickstand has a rigid design and can also be angled to position your frame view perfectly.

NOTE: You can adjust the frame to a fitting angle by bending the kickstand. We suggest you bend the kickstand the way as below demonstration.

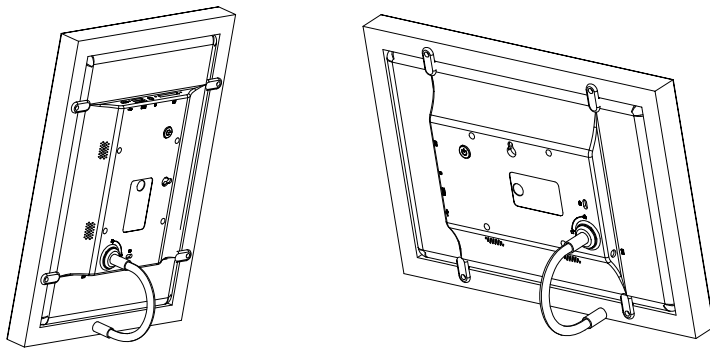

3 Connect the frame into the DC connector, and plug the power adaptor into the wall socket, the frame will turn on automatically, then you can follow the on-screen instructions.

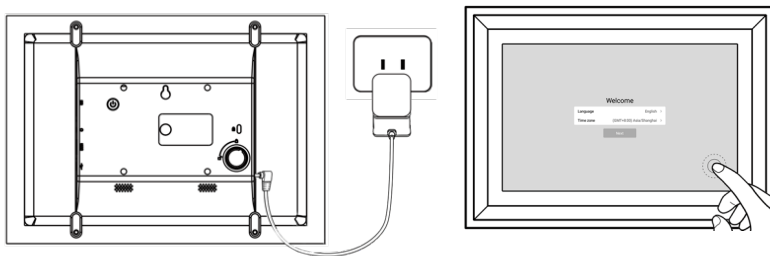

GETTING STARTED

If you are new to using Frameo then start by following the Frameo Quick Setup or follow the on-screen guide when powering it on for the first time.

Once you have set up your Frameo frame, you can start connecting it to your friends and family.

Frameo App

To send photos to your frame, use the Frameo App for iOS or Android.



Find the Frameo App by scanning this code:

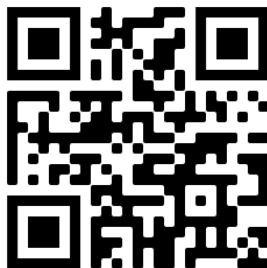

For Android:

Search for "Frameo" on [Google Play](#)

For iOS:

Search for "Frameo" on [App Store](#)

FRAMEO QUICK SETUP

When starting your frame for the first time, you will need to setup the frame.

- Select a language. This will be the language used on the Frameo.
- Connect your frame to the internet by connecting it to a Wi-Fi.
- Frameo may ask you to update to the latest version.

NOTE: It is recommended to update your frame before continuing if asked to.

- Enter your name, and the location where you have placed your frame e.g. “John Doe” and “Living room”, “Kitchen” or “Office”. Finally set the time zone if not already correct.

START USING FRAMEO

Next step is to connect Frameo with your friends and family by providing them with a code from your frame.

If you want to be able to send photos to the frame yourself, start by downloading the App for iOS or Android on App Store or Google Play. Then use the code to connect your frame and App as described below.

Connecting a new friend

Make sure that your friend has downloaded and installed the Frameo App.

Click the add friend icon on your frame . A dialog will appear showing a connection code, which is valid for 12 hours.

Now share this code in whatever fashion you prefer e.g. SMS, E-Mail, IM, phone call, to your friend.

Once your friends have added the code in their Frameo App, they will automatically appear on your frame and be able to send you photos.

Read chapter [Change options for a friend](#) to allow connected friends, to retrieve and share the connection code via the smartphone app.



NAVIGATING YOUR FRAMEO

Swipe left or right to go through your photos.

To access the menu, simply tap once on the screen.



In the menu you will find the most used features.

Add friend

This will generate a code that you can share with your friends and family so they can connect and send photos to your frame.

Settings

Opens the [Settings](#).

Power menu

Opens the [Power menu](#)

Hide photo

Hides the current photo. This means that the photo will no longer be shown in the slideshow. If needed the photo can be shown again through the settings menu.

Gallery

Opens a gallery which allows for easy and fast navigation through your photos.

Fit to frame/Fill frame

This toggles how the photo is shown.

The Fill frame option is the default. The photo is scaled so that it fills the whole screen. It will be centered around what is selected as the most important part. See the first picture below.

Fit to frame will make sure that the entire photo is shown on the screen. See the second picture below.



Adjust photo



Allows you to adjust the position of the photo in the frame for an even better fit. Here you can also use to rotate  your photo.

Interacting with videos

When a video is shown two additional controls are shown. One for play/pause of the video and one to control the volume level for video sounds.





Press  to start the video playback. Pressing  will pause the video playback.

Press  to open the volume slider.

Use the slider to adjust the volume level for video sounds. Pressing  will mute the video while pressing  will unmute the video.



Power menu

Tap the power icon  to access the power menu. Here you can power off using , restart your frame using  or enter sleep mode using .



NOTE: Make sure to always use the power off button on the device or in the power menu to turn Frameo off. Never disconnect power when Frameo is running.

SETTINGS

Through the settings, you can personalize your frame to your needs.

My frame

Frame name

Changes the name of your frame. This is also the name that connected friends and family will see in their list of connected frames in the smartphone App.

Frame location

Changes the location of your frame. This is the location displayed on your friends' and family's list of connected frames which can help to distinguish frames from each other.

Set language

Sets the language used on the frame.

Set time zone

Sets the time zone used on the frame.

Enable/Disable 24-hour format

Enables, and disables, 24-hour time format.

Manage photos

In the manage photos menu you can see how many photos are on your frame and the storage they use. You can also see the amount of storage left available on your frame for storing new photos.



Show/hide photos

Select which photos to hide by tapping them. Hidden photos will NOT be deleted from your frame and you can always select them to be shown again.

Use  to hide or show all photos.

Delete photos

Select photos that you want to permanently delete from your frame by tapping the photo.

Use  to select or deselect all and  to permanently delete the selected photos.

Import photos

Allows you to import photos from an external storage (e.g. SD card).

Before you try to import photos, make sure you have an external storage (e.g. SD card) inserted into your frame with the photos you wish to import.

Start by selecting the photos that you want to import onto your frame. Once selected tap the import button  to start the import process.

Use  to select or deselect all photos on the external storage (e.g. SD card).

Use  to set the sort order of photos before import and  to order by ascending/descending.

It is currently not possible to add a caption or define the most important part of the photo when using the import function. An alternative for this is to add yourself to your friend list and send the photos using the App.

Export photos

Allows you to export photos from the frame to external storage (e.g. SD card).

The export function will export all photos on the frame as well as profile pictures.

My Friends

This list contains all the connected friends that are allowed to send photos to your frame.

Change options for a friend

Click the options icon  to open the friend options menu. From here you can allow/disallow if a friend may share the code to the frame. If this is enabled the friend can retrieve and share the code to the frame from his/her App.

From the options menu you can also delete a friend, by pressing the DELETE FRIEND button. This will remove the friend from the list and thereby remove their permission to send photos to the frame. You will then be asked to confirm the removal and if you would like to remove all photos previously received from this friend.

Add person

To allow a new person to send you photos, simply tap the add friend button  and share the presented code in whatever way you prefer.

Display

Brightness level

Adjust the brightness level of the screen.

Sleep mode

Frameo offers a sleep mode which turns off the screen to reduce power consumption. The default setting is to turn off the screen at 23:00 and turn on the screen again at 07:00. To change this just set the sleep mode start/end time.

NOTE: *Your frame is not powered down or in standby, so you will still be able to receive photos during sleep mode.*

Slideshow

Timer

Set the duration that a photo should be displayed before showing the next photo.

Show caption

Sets whether or not to display the captions that your friends have sent with the photo. Check to display captions.

Uncheck to hide captions.

Fill frame

Sets the default frame photo setting. Check to set default to fill which makes the photos fit the device screen according to the most important part of the photo. Uncheck to make the photo fit inside the screen of the device, adding blurred bars on the sides or top/bottom.

Photo display order

Sets the order in which your photos are displayed on the frame.

- By date: Photos are shown newest to latest.
- Shuffle: Photos are shuffled and shown in a random order.

Autoplay

Enables/disables autoplay of videos in the slideshow. Videos can always be manually started regardless of this setting.

Video playback

Determines how videos should be played when autoplay is enabled.

- Loop videos: The video will loop until the slideshow timer is up.
- Play once: The video will play once and show it's thumbnail until the timer is up.
- Play once and continue: The video will play once and continue to the next photo, or video, once it completes.

Video volume

Adjust the volume level for video sounds on the frames.

Wi-Fi

Set which Wi-Fi the frame connects to. If you are connecting to a network with a captive portal Connection status will say that Wi-Fi login is required and show . Tap this to open a login screen where you can enter credentials to access the network.

Wi-Fi details

Use  to show details about the current connected Wi-Fi.

Reset Wi-Fi

Use  to delete all Wi-Fi information and restart your frame.

Notifications

Show notifications

Enables/disables whether notifications are shown in the slideshow (e.g. when a new photo is received).

Notification volume

Adjust the volume level for notification sounds.

Storage space

Enables/disables notifications shown when frame storage is low.

Backup

Enables/disables notifications shown if automatic backup has failed.

Network connection

Enables/disables notifications showing network connection status.

New photos

Enables/disables notifications shown when receiving new photos.

New friends

Enables/disables notifications shown when new friends are added.

Software update

Enables/disables notifications shown when a software update has been installed.

Feature news

Enables/disables notifications shown when new exciting features are added.

Backup and Restore

Backup frame to external storage (e.g. SD card)

Tap to make a backup of your photos, friends and settings. The time of the latest successful backup is also displayed here.

NOTE 1: Any existing backup on the external storage will be overridden!

NOTE 2: This photo frame only supports max 32GB external devices

Automatic backup

If checked, your frame will automatically take a backup within 30 hours of receiving new photos or making changes to your frame.

Restore from backup

Before you attempt to restore your frame, start by confirming that your backup is up-to-date. This is done by confirming the date under “Backup frame to external storage (e.g. SD card)”. If e.g. the last backup is too old or if no backup is made, then press the “Backup frame to external storage (e.g. SD card)” button to make a new backup.

NOTE: To keep both the old and the new frame operational at the same time after restoring from backup, please make sure that both frames are updated to the latest version beforehand.

If you wish to restore a backup on a frame that has already been setup, then you must first reset the frame. This is done by pressing the “Reset frame” button. This will delete all data on the Frameo and reset the Frameo to its setup screen.

On the setup screen you can select the “Restore from backup” button which will restore your frame according to the backup.

If the “Restore from backup” button isn’t visible, then confirm that the external storage (e.g. SD card) is correctly mounted.

Reset frame

Removes all data from your frame.

NOTE: *This will permanently remove all your photos, friends/connections and settings.*

Help

Open source libraries

Opens a list of open source libraries used in the App and their licenses.

Share anonymous analytics data

Sharing anonymous analytics data helps us tremendously to improve the Frameo software. We understand if you do not wish to share this data with us. Keep it checked if you wish to help us improve Frameo. Set unchecked to deny the sharing of anonymous analytics data.

Guide

Opens the quick start guide, that was shown when you first started the frame.

About

Android version

See what version of Android that is installed on the frame.

Peer ID

This is a unique ID for your photo frame. When contacting our support, please provide this ID with your message.

MAC

Shows the MAC address of your frame.

Frameo version

Shows what version of the Frameo software is currently installed on your frame.

Up time

Shows how long the photo frame has been powered on.

Check for update

Check if an update is available for your frame.

Beta program

If checked the device will join the Beta program where it will receive updates more frequently and before normal release devices.

PRIVACY

For more information regarding privacy, please visit www.lovcube.com.

SUPPORT

Please contact support@lovcube.com for FAQ, support and to provide feedback.

FULL ONE YEAR MANUFACTURER'S WARRANTY

LOVCUBE warrants the product hardware components against defects in materials and workmanship when used in accordance with the company's documentation for a period of one (1) YEAR after the date of original purchase from the company. If a hardware defective arises and a valid claim is received within the Warranty Period, at its option and to the extent permitted by law, Company will either (1) repair the hardware defect at no charge, using new or refurbished replacement parts, (2) exchange the product with a new or manufactured from new or serviceable used parts and is at least functionally equivalent to the original product or (3) refund the purchase price of the product.

We only cover warranty for purchase made within the USA, Canada, UK.

OBTAINING WARRANTY SERVICE

Please access and review the online help resources referred to in the documentation accompanying this hardware product before requesting warranty service. If the product is still not functioning properly after making use of these resources, please contact our representatives at support@lovcube.com. No replacements will be sent out by the manufacturer until the returned item is received.